

Haier

Combined fridge - freezer - Instruction for use

CFE633CW/U
CFE633CS/U
CFE633CB/U
AFL631CW/U
AFL631CS/U
AFL631CB/U



DECLARATION OF CONFORMITY

The manufacturer of the product/s described herein, to which this description refers, declares on its sole responsibility that the product/s meet the relevant fundamental safety, health and protection requirements of the relevant EU guidelines and that the corresponding test reports are available for examination by the relevant authorities and can be requested from the seller of the appliance, especially with regard to CE Declaration of Conformity issued by the manufacturer or with the manufacturer's approval. Moreover, the manufacturer declares that the parts of the appliance described in this user manual, which come into contact with fresh food, do not contain any toxic substances.

ELECTRICAL CONNECTION (UK ONLY)

For your safety please read the following information.

Warning: This appliance must be earthed.

The appliance must be connected to a 220 - 240 volts 50 cycle AC supply by means of a three pin socket, suitably earthed and should be protected by a 13 amp fuse in the plug. The appliance is supplied with a standard 13 amp 3-pin plug fitted with a 13-amp fuse. Should the fuse require replacement, it must be replaced with a fuse rated at 13 amp and approved to BS1362.

If the mains plug is unsuitable for the socket outlet in your home or is removed for any other reason, then the cut off plug should be disposed of safely, do not insert the cut off plug into a mains outlet to prevent the hazard of electric shock. Remove the fuse before disposal.

There is a danger of electric shock if the cut off plug is inserted into any 13-amp socket outlet.

How to wire a 13 amp plug:

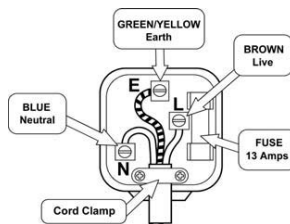

Important

The wires in the mains lead on this appliance are colored in accordance with the following code:

Green and Yellow - Earth

Blue – Neutral

Brown – Live

As the colours may not correspond with the markings identifying the terminals in your plug proceed as follows.

The green and yellow wire must be connected to the terminal in the plug which is marked with the letter E or with the earth symbol \perp or colored green and yellow.

The blue wire must be connected to the terminal marked N.

The brown wire must be connected to the terminal marked L.

You must make sure the mains cord is firmly secured under the cord clamp.

Warnings:

Keep ventilation openings, in the appliance enclosure or in the built in structure, clear of obstructions.

Do not use mechanical devices or other means to accelerate the defrost process, other than those recommended by the manufacturer.

Do not damage the refrigerant circuit.

Do not use electrical devices inside the food storage compartments of the appliance, unless they are of the type recommended by the manufacturer.

Table of Contents

Dear Customer

Our sincere thanks for having chosen this quality product, designed and engineered to meet every requirement of modern-day living. This appliance will provide many years of trouble-free service and fully live up to all your expectations.

This user manual covers a number of different appliances. Some slight differences may therefore apply to some models.

Before use

Key features	1
Description of various components	2-3
Safety precautions	4-6
Placing environment	7
Preparation prior to use	8-9

Use instructions

Function introduction	10-13
About the fridge storage compartment	14-15
Fridge storage precautions	16
Tips on food storage in the fridge Storage compartment	17
Freezer storage precautions	18

Maintenance

Defrosting and cleaning	19
Stopping use	20
Troubleshooting	21-22
Technical data	23

- Please read this Operation Manual carefully before using the appliance.
- Keep this Manual for future reference.
- See the physical object for the appearance, color and the door pattern.

Key Features

- ◆ The freezer door is replaced by two drawers. This can better facilitate food access, featuring both energy saving and convenience (only on some models).
- ◆ Shelf structure.
- ◆ Innovative long-efficiency lighting system.
- ◆ Foldaway wine holder.
- ◆ Large crisper with humidity adjustment.
- ◆ Holiday function.
- ◆ Power ON/OFF function is set on the display panel (only on some models).
- ◆ Fridge storage compartment can be set on/off separately.
- ◆ Intelligent alarm function: automatic alarm at over temperature, malfunction, door open.
- ◆ Touch keys (only on some models).
- ◆ Zero degree fresh keeping.

Description of various components

Models: AFL631CW/U
AFL631CS/U
AFL631CB/U

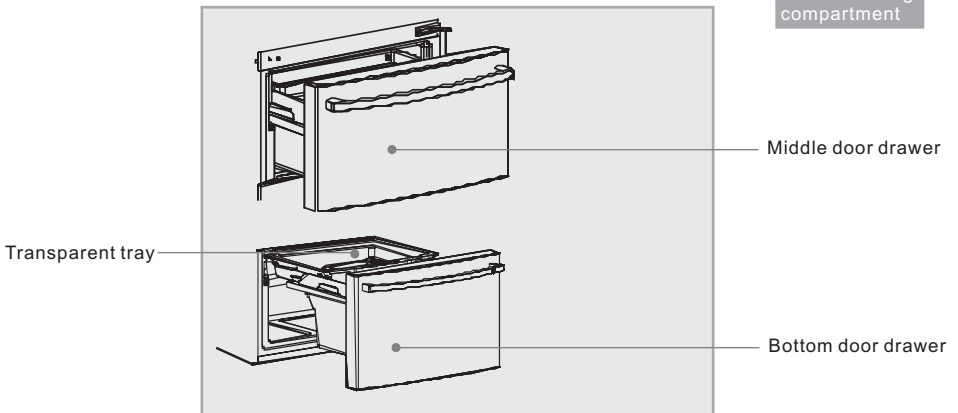
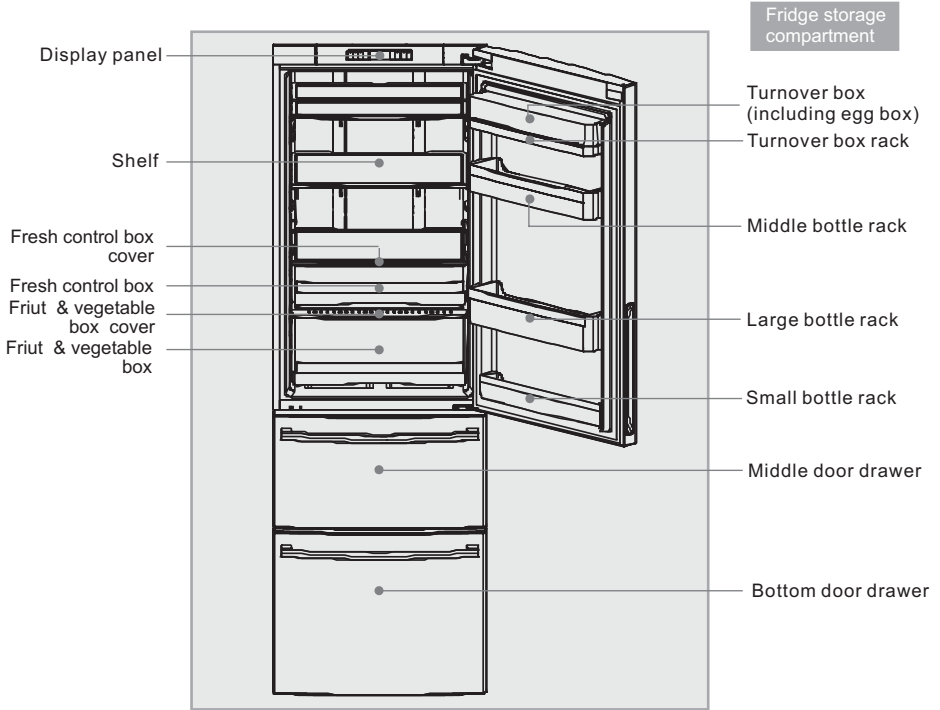

Note

The accessories shown are for several models. There may be slight differences between them and the ones on your refrigerator.

Descriptions of various components

Models: CFE633CW/U
CFE633CS/U
CFE633CB/U

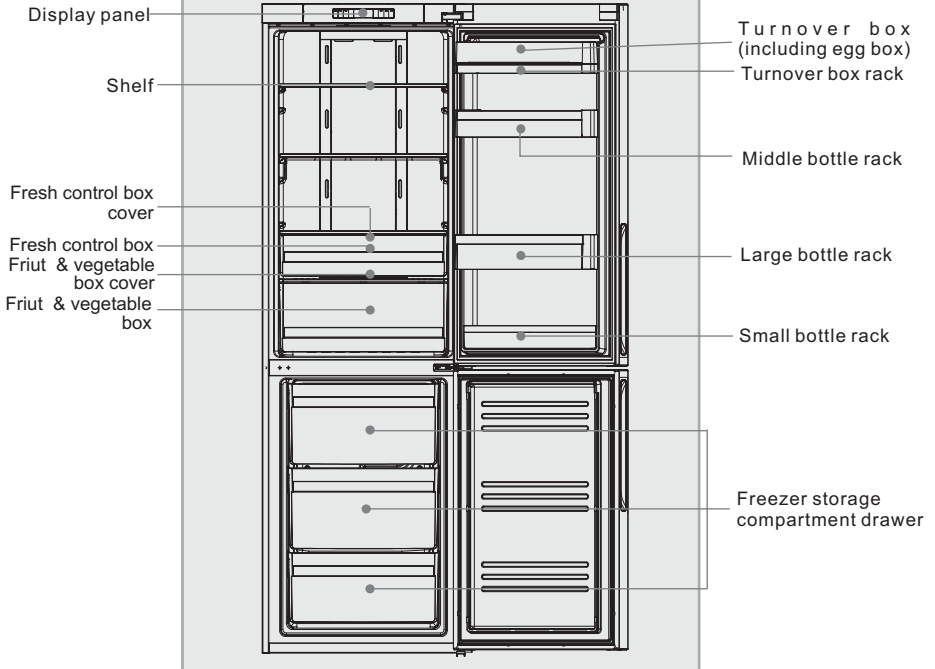

Note

The accessories shown are for several models. There may be slight differences between them and the ones on your refrigerator.

Safety precautions

The refrigerator is operated through a 220-240VAC/50Hz power supply. Abnormal voltage fluctuation may cause the refrigerator to fail to start, or damage to the temperature control or compressor, or there may be an abnormal noise when the compressor is operating. In such a case, an automatic regulator shall be mounted.

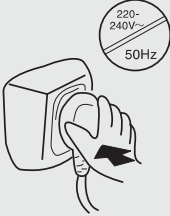

A dedicated socket with reliable grounding must be provided for the refrigerator. The refrigerator's power cable is fitted with 3-cord (grounding) plug that fits a standard 3-cord (grounding) socket. Never cut off or dismount the third pin (grounding). After the refrigerator is installed, the plug should be accessible.

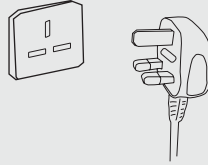

Care for the power cord

- Hold the plug, not the cord, when unplugging the refrigerator.
- Ensure that the power cord is not trapped by the refrigerator. Do not step on the power cord.
- Take care not to roll over the power cord or damage it when moving the refrigerator away from the wall.

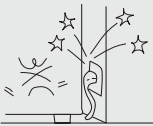

If the mains cord becomes damaged, it must be replaced by the manufacturer, its service agent or similarly qualified person with a specially prepared cord of the same type and rating.

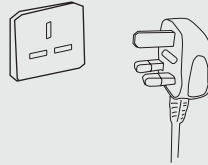

If coal gas or other inflammable gas is leaking in the vicinity of the refrigerator

- Turn off the valve of the leaking gas;
- Open the doors and windows;
- Do not unplug or plug the power cords of the refrigerator or any other appliance.



Unplug the refrigerator for the following reasons:

- Cleaning or maintenance;
- Lamp replacement



Safety precautions

Never store inflammables, explosives or corrosive materials in the refrigerator.



Do not store medicines, bacteria or chemical agents in the refrigerator. This refrigerator is a household appliance. It is not recommended to place materials that require strict temperatures.

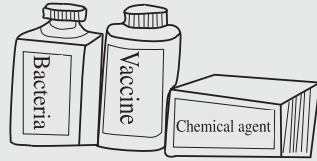

Do not store or use gasoline or other inflammable materials in the vicinity of the refrigerator to avoid a fire.



Do not place unstable articles (heavy objects, containers filled with water) on the top of the refrigerator, to avoid personal injury caused by falling or electric shock caused by contact with water.

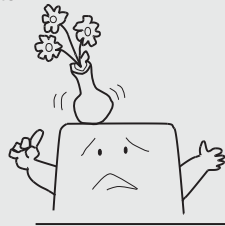

Do not swing from the bottle racks on the door. The door may be pulled slant, the bottle rack may be pulled away, or the refrigerator may topple. Do not step on the freezer storage compartment door or cabinet when putting in or taking out food.



Do not touch the inside surface of the freezer storage compartment when in operation, especially with wet hands, as your hands may freeze onto the surface.



Safety precautions

Open/close the doors only with the handles. The gap between the two doors and between the doors and the cabinets is very narrow. Do not extend your hands in these areas to avoid pinching your fingers. Open or close the refrigerator doors only when there are no children standing within range of door movement.

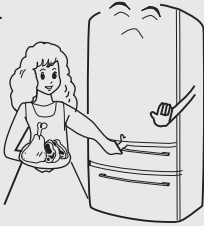

To ensure the refrigerator's electrical insulation, do not spray or flush the refrigerator when cleaning, nor place the refrigerator in a damp area or a location where it may be splashed with water.



Disassembly and alteration of the refrigerator must be authorized. Any agitated movement of the refrigerator may damage the cooling pipes. Property loss or personal injury may result. Repair of the refrigerator must be performed by professional personnel.



Never store bottled beer or beverages in the freezer, as these will burst during freezing.



Unplug the refrigerator in the event of a power interruption or before cleaning. Allow at least 5 minutes before restarting the refrigerator, as frequent starting may damage the compressor.

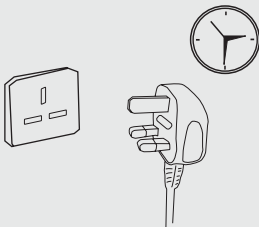

When discarding the refrigerator, to avoid the accidental entrapment of children, please remove the refrigerator doors, door gaskets and shelves and put them in an appropriate place.

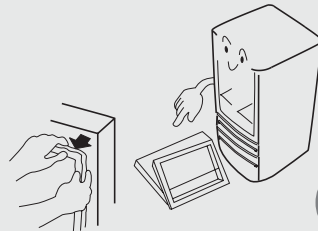

Placing environment

Leveling of the cabinet

The refrigerator should be placed on a flat and solid surface. If the refrigerator is placed on a pedestal, flat, strong and fire-resistant materials must be used. Never use the foam packing material for a pedestal. If the refrigerator is slightly unstable, you can prolong or shorten the adjustable feet of the refrigerator by turning them clockwise or counterclockwise.

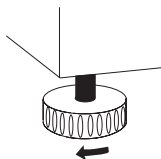

The direction shown is clockwise



Do not store too much food in the freezer storage compartment to avoid long operation time of the compressor or falling food. It is recommended not to exceed the load line of the drawers. The total weight of the food should not exceed 30kg. To prevent the food from falling on the ground, do not pull open the freezer drawer too strong or slanted.

Do not use the appliance if the mains cable is damaged or if the product does not work as expected or if it is damaged in any way.

If the supply cord is damaged, it must be replaced by the manufacturer, its service agent or similarly qualified persons in order to avoid a hazard.

Warning: This appliance is not intended for use by persons (including children) with reduced physical, sensory or mental capabilities, or lack of experience and knowledge, unless they have been given supervision or instruction concerning use of the appliance by a person responsible for their safety.

Warning: Children should be supervised to ensure that they do not play with the appliance. This appliance is intended for domestic use only, commercial or any other use may invalidate the warranty and might be dangerous.

Never place the refrigerator in a damp area or a location where it may be splashed with water. Clean and dry any water splashes and stains with soft cloth.

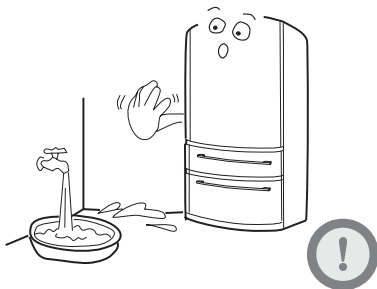

The refrigerator should be placed in a well-ventilated place not far from a drink water source. A space of at least 20cm above and 10cm around the refrigerator must be kept.

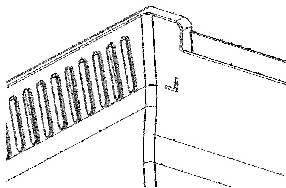
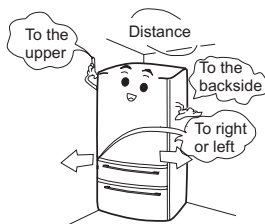

Preparation prior to use

- ① Remove all package parts
Please also remove the foam base and the adhesive tape fixing accessories.

- ② Check accompanying accessories and documents
Check the items inside the package box against the Packing List. Please inquire with the purchase shop if there is any discrepancy.



- ③ Install the handles
(AFL631CW/U/AFL631CS/U/AFL631CB/U) Take out the two handles from the accessory box and insert them in the handle seats respectively as shown in the figure. Secure the handles on the doors with the supplied (4) screws from bottom to upper direction.

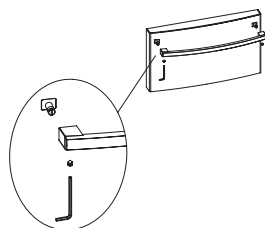

- ④ Move the refrigerator into a proper location
(See section "Placing environment")

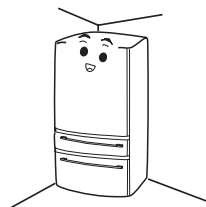

- ⑤ It is advisable to clean the cabinet before use
Please clean the inside and outside of the refrigerator with water before putting into any food in it.



- ⑥ Idle standing
After the appliance has been leveled and cleaned, let it remain idle for at least 6 hours before switching it on so as to ensure its normal running.

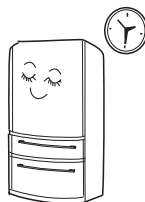

Preparation prior to use

① Connection to power supply

When the refrigerator is connected to power supply, the fridge temperature and freezer temperature are automatically set to 5°C and -18°C respectively.

② Operation modes of the refrigerator

Manual adjustment mode: can set temperature by pressing the temperature setup key (see "Function description" hereafter).

③ Loading the refrigerator with food

Load the refrigerator with food after it has been operates for a period and the inside is cool enough.



Note

Some time will be required for the refrigerator to reach the set temperature when the setting is changed. The length of this period depends on the difference between the existing and set temperatures, ambient temperature, door opening frequency and the amount of food in storage.

Function introduction

1 Models: CFE633CW/U/CFE633CS/U/CFE633CB/U

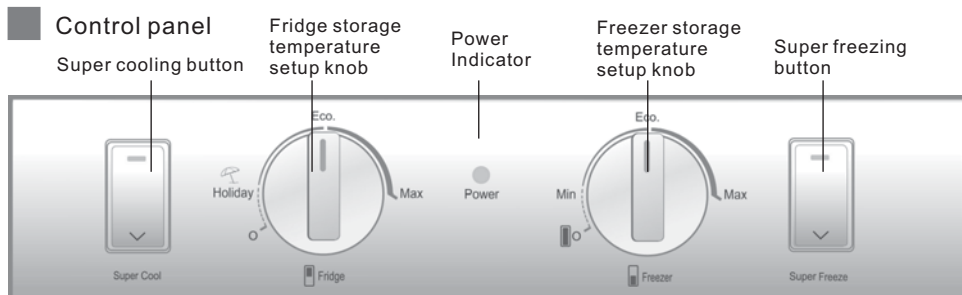

Initial powering on

Upon initial powering on, the power indicator will illuminate. There will be alarm due to high temperature in the freezer storage compartment. You can cancel the alarm by pressing any key.

Fridge storage temperature setup

The temperature in the fridge storage compartment can be set by turning the fridge storage temperature setup knob. There are three temperature positions for refrigerating: Holiday, ECO. and max.

Freezer storage temperature setup

The temperature in the freezer storage compartment can be set by turning the freezer storage temperature setup knob. There are three temperature positions for freezing: Min, ECO. and max.

Super cooling

Select this function after you have put fresh food in the fridge storage compartment. Press the super cooling button, the refrigerator activates this function and corresponding indicator illuminates. This function will automatically deactivate when the temperature decreases to the required level. You can also deactivate it by pressing the super cooling button again.

When the temperature in the refrigerator storage compartment is too low, the super-cooling function may not work. That is, when you press the "super-Cooling" button once, the buzzer will beep once and the indicator will not blink, meaning the temperature in the refrigerator storage compartment is too low and the super-cooling function doesn't need to be activated.

Super freezing

Select this function after you have put large amount of food in the freezer storage compartment. Press the super freezing button, the refrigerator activates this function and corresponding indicator illuminates. This function will become automatically deactivate after 24 hours. You can also deactivate it by pressing the super freezing button again.

Holiday function

Turning the fridge storage temperature setup knob to "Holiday" will activate the holiday function of the fridge storage compartment. It will operate at a relatively high temperature. (Please remove any fresh food from the fridge storage compartment and close the door before activating this function)

Display control

The display screen will turn off automatically 1 minute after an operation is finished. It will be lit up by opening the door or pressing any key. (Alarm does not light up the display screen)

Door open alarming

When the refrigerator door is open for more than 3 minutes, the super cooling indicator will flash and the buzzer will sound 3 beeps every 30 seconds. The buzzer can be silenced by closing the door or pressing any key.

Function introduction

Over temperature alarm

When the temperature in the freezer storage compartment rises to a certain value, the Super Freeze indicator will flash and the buzzer will sound 1 beep every second. The buzzer may be silenced when the temperature in the freezer storage compartment drops to a specified level or by pressing any key.

Turning off the fridge storage compartment

Set the fridge storage temperature to 0. The fridge storage compartment will be turned off while the freezer storage compartment operates normally.

Turning off the refrigerator

Set the freezer storage temperature to 0. The refrigerator will stop operating. This function is not equivalent to turning off the power.

2 Models: AFL631CW/U/AFL631CS/U/AFL631CB/U

Control panel

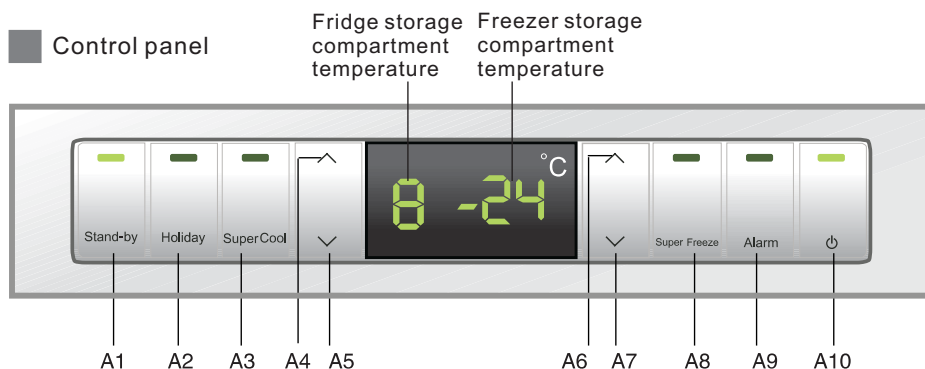

- A1 Switch on/off the fridge storage compartment
- A2 Holiday function
- A3 Super cool
- A4 Fridge temperature up
- A5 Fridge temperature down
- A6 Freezer temperature up
- A7 Freezer temperature down
- A9 Over-temperature/door open alarm

- A2 Holiday function
- A4 Fridge temperature up
- A6 Freezer temperature up
- A8 Super freeze
- A10 Power ON/OFF

Initial powering on

When the refrigerator is powered on for the first time, the power indicator and the fridge storage compartment indicator will light. The fridge storage temperature will be displayed as “-” due to the high temperature inside. The freezer storage temperature will be displayed as“- -” due to high temperature inside. The buzzer will beep. Press key A9, and the buzzer will be silenced. After the temperature decreases to certain level, the displayed temperatures of the fridge storage compartment and the freezer storage compartment will become the ex-factory settings “5” and “-18” respectively.

Fridge storage temperature setup

Press key A4 or A5 to set the fridge storage temperature. The fridge storage temperature cycles from 2 to 8. The setting is confirmed automatically 5 seconds after the operation is finished or by pressing any other key.

Function introduction

Freezing storage temperature setup

Press key A6 or A7 to set the freezer storage temperature. The freezer storage temperature cycles from -16 to -24°C. It will be confirmed automatically 5 seconds after the operation is finished or by pressing any other key.

Super cooling

Select this function after you have put fresh food in the fridge storage compartment. Press key A3, and this function is activated and the corresponding indicator illuminates. This function will automatically deactivate when the temperature decreases to the required level. You can also deactivate it by pressing key A3 again.

When the temperature in the refrigerator storage compartment is too low, the super-cooling function may not work. That is, when you press the “super-Cooling” button once, the buzzer will beep once and the indicator will not blink, meaning the temperature in the refrigerator storage compartment is too low and the super-cooling function doesn't need to be activated.

Super freezing

Select this function after you have put large amount of food in the freezer storage compartment. Press key A8, this function is activated and the corresponding indicator illuminates. This function will become inactive automatically after 24 hours. You can also deactivate it by pressing key A8 again.

Holiday function

Press key A2, corresponding indicator illuminates and the holiday function of the fridge storage compartment is activated. It will operate at a relatively high temperature in Holiday mode. The fridge storage temperature will be indicated as “-” (Please take out the fresh food in the refrigerator and close the door before activating this function). Press key A2 again, and the corresponding indicator goes off and the refrigerator comes into normal control.

Display control

The display screen will turn off automatically 1 minute after an operation is finished. It can be lit up by opening the door or pressing any key. (Alarm does not light up the display screen)

Door open alarming

When the refrigerator door is open for more than 3 minutes, the alarm indicator will flash and the buzzer will sound 3 beeps every 30 seconds. The buzzer can be silenced by closing the door or pressing key A9.

Over temperature alarm

When the temperature in the freezer storage compartment rises to a certain value, the alarm indicator will illuminate solid and the buzzer will sound 1 beep every second. The buzzer can be silenced when the temperature in the freezer storage compartment drops to a specified level or key A9 is pressed.

Turning off the fridge storage compartment

Press and hold key A1 for 3 seconds, and the corresponding indicator will turn off and the fridge storage compartment will be turned off while the freezer storage compartment operates normally. The fridge storage temperature indication icon will also go off. Press and hold key A1 for 3 seconds again, the corresponding indicator will illuminate, the fridge storage compartment will be turned on, and the fridge storage temperature indication icon will recover.

Turning off the refrigerator

Function introduction

Press and hold key A10 for 3 seconds, corresponding indicator will go off, the display panel will go off and the refrigerator will stop operating.

Press and hold key A10 for 3 seconds again, corresponding indicator will light up, the display panel will light up, and the refrigerator will start operating normally.

This function is not equivalent to turning off the power.

Fault indication

When E or F is displayed due to fault, the refrigerator can still refrigerate. Please contact professional after-sales service personnel as soon as possible.

About the fridge storage compartment

Please put the food to be stored for short period or for daily consumption in the fridge storage compartment:

Although the average temperature in most areas in the fridge storage compartment can be regulated between 0°C and 10°C, extended period of food storage is not recommended. The fridge storage compartment should only be used for short-term storage.



Adjusting shelf height

The shelf can be relocated to accommodate food size or height. To adjust the height of a shelf, remove it first in this way: uplift its front edge and then pull it out.

To install the shelf, put the dogs on both sides of the shelf on the supporting ribs and push it to the most inward end.

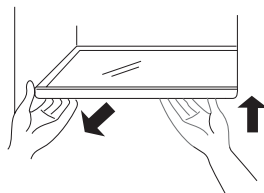

Fruit & Vegetable box

The refrigerator has a crisper. You can adjust the humidity inside it according to the properties of the foods.

● Turning the humidity control button rightward enables the crisper to keep in a higher humidity suitable for cucumbers, grapes, Chinese gooseberries, persimmons, etc.

● Turning the humidity control button leftward enables the crisper to keep in a lower humidity suitable for strawberries, oranges, beans, garlic, watermelon, plums, tomatoes, etc.

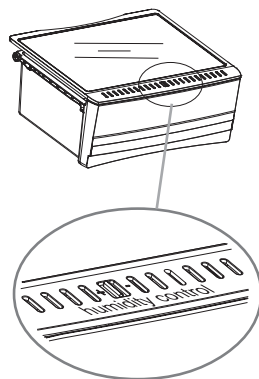

Fresh control box

The temperature in this box is kept at approx 0°C, it may be slightly changed due to the different ambient temperature or refrigerator working style. It is suitable to store fresh fish, meat and cooked food in 1~2 days.

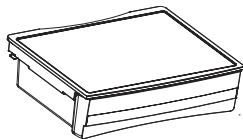

Disassemble to clean the bottle rack

To take out a bottle guard, uplift the bottle guards in direction ① and grip both sides and pull it out in direction ②. After cleaning, install it with the operation in the reversed direction.

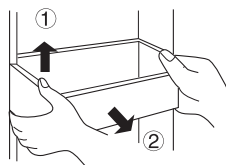

About the fridge storage compartment

Use of the foldaway shelf(Only AFL 631C* models)

Fig. ① shows the extended state of the foldaway shelf in which you can put lower food containers.

Fig. ② shows the folded state of the foldaway shelf in which you can put higher food containers.

To fold the shelf from state ① to state ②, simply push structure A upwards, and push structure B inward in the direction of the arrow shown in the figure.

To extend the shelf from state ② to state ①, push structure A upwards, and pull structure B in the direction of the arrow shown in the figure.

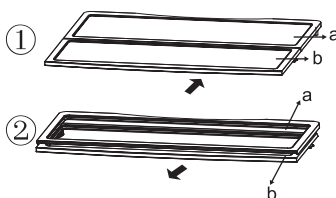

Use of the wire wine holder(Only AFL 631C* models)

Fig. ① shows the folded state of the wire wine holder. In this state large space can be spared.

Fig. ② shows the extended state of the wire wine holder. In this state it can hold various wines.

To extend it from state ① to state ②, simply pull the wire down. The maximum load of the bottle holder is 10 kg.

To fold it from state ② to state ①, simply push the wire up.

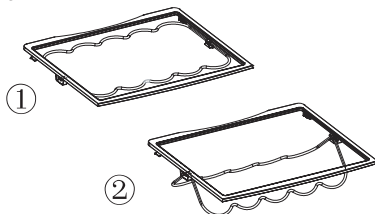

Note

make sure to keep the two ends of a shelf on the same level. Otherwise it may fall or the food on it may dump.

Recommended storage areas for various foods

As cold air circulates inside the refrigerator, there is temperature difference inside the fridge storage compartment. Different foods should be placed in different areas according to their properties.

- ① Eggs, butter, cheese and etc.
- ② Drinks, canned food and etc.
- ③ Seasonings and pickled food
- ④ Beverages, canned food, cake, etc.
- ⑤ Milk, cheese, etc
- ⑥ Cooked meat, fresh fish and meat, etc.
- ⑦ Fruit, vegetables, salad, etc.

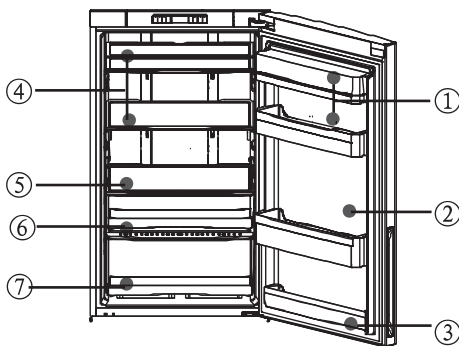

Lamp in the fridge storage compartment and its replacement

Parameters of the lamp: 12V, max 1W(the power depends on the model). The lamp adopts LED as its light source, featuring low energy consumption and long service life. If there is any abnormality, please contact the after-sales service personnel.

Fridge storage precautions

Hot foods must be cooled to room temperature before storing in the refrigerator.

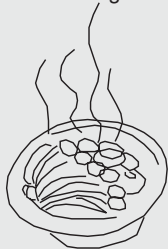

Clean the food and dry any droplets on it before placing in the refrigerator.



Food to be stored should be properly sealed. This will prevent moisture in the food from evaporating and prevent them from spoiling.



Sorted storage of food.

Food to be stored should be sorted according to their category. Food consumed daily should be placed on the front part of the shelves. This can avoid unnecessary delays in door opening as well as expiration of the storage period because you forgot to eat it.



Do not store excess quantities of food. Food should be stored with spaces in between them. This allows cold air to flow smoothly and therefore obtain better storage results.

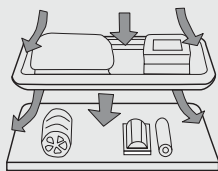

Do not place the food too near to the inner walls.

Do not store foods with high moisture content clinging to the inner walls. Otherwise they may freeze to the walls. Place food a little away from the inner walls.



Note

Avoiding food (especially oil food) contact with the inner liner directly, as oil can erode the inner liner. So it's better to clean the oily dirt whenever it is found.

Tips on food storage in the fridge storage compartment

For turnip radish and other similar vegetables, please cut off their leaves before storage so as to prevent the nutrition from being absorbed by the leaves.

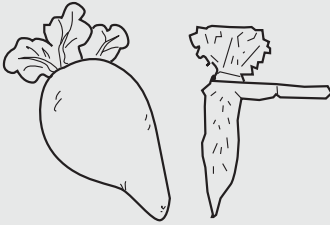

Defreeze frozen food in the fridge storage compartment. In this way you can use the frozen food to decrease the temperature in the compartment and save energy.

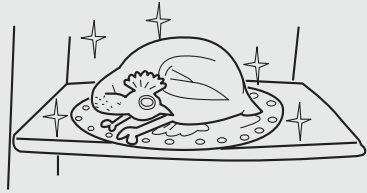

Some vegetables, for example, onion, garlic, ginger, water chestnut, and other rhizomatic foods, can be stored for long periods at normal temperature. There is no need to store them in the refrigerator.

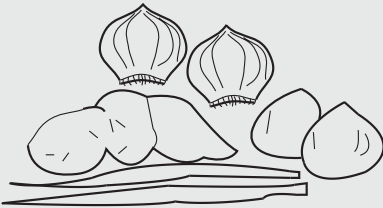

The metabolism of vegetable marrow, melons, pawpaw, banana, pineapple can be quickened in the refrigerator, so it is not suitable to store them in the fridge storage compartment. But storing green fruits in the refrigerator for certain periods can promote its maturing.



Freezer storage precautions

Hot food should not be stored in the refrigerator until it has cooled down to room temperature



Food cut into small portions will freeze faster and be easier to defrost and cook. The recommended weight for each portion is less than 2.5kg.

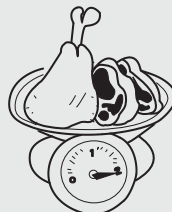

It's better to pack food before putting it in the freezer. The outside of the packing must be dry to avoid bags sticking together. Packing materials should be odor-free, airtight, non-poisonous and nontoxic.

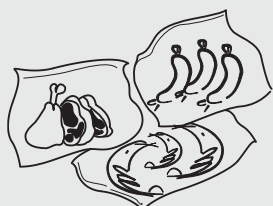

In order to avoid expiration of storage period, please note the freezing date, time limit and name of the food on the packing according to the storage periods of different foods.

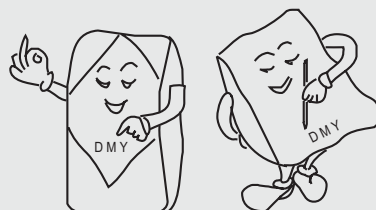

Only take the required amount of food from the freezer. Defrosted food cannot be re-frozen unless it is first cooked, otherwise it may be less edible.

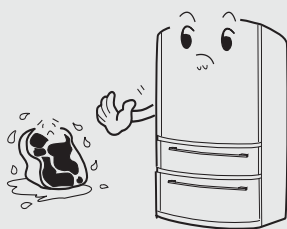

Do not load excessive quantities of fresh food in the freezer. It is better to refer to the cooling capacity of the refrigerator. (See "Technical data".)

Defrosting · Cleaning

■ Defrosting the freezer

The freezer defrosts automatically. No manual operation is needed.

■ Cleaning

The refrigerator should be cleaned regularly to prevent bad stored food odors.

- For safety, unplug the power cord before cleaning the refrigerator.
- Clean the refrigerator with a soft cloth or sponge with warm water (can be added with mild detergent).
- Dry water droplets on the refrigerator surfaces with a dry cloth.

■ Use of the cleaning filter (on some models)

● The design service life is from 5 to 6 years. But as the kind and concentration of odors in each refrigerator is uncertain due to different operation condition and environment, we recommend you to set the replacement cycle within 3 years.

● After prolonged use, you can put it under sunshine for 30 minutes to recover the deodorization effect. To clean, please use slow water flow.



Note

- ① The refrigerator is very heavy. When you are moving it for cleaning or repairs, take care not to damage the floor. Keep the refrigerator upright during moving. Do not move the refrigerator by rocking it to avoid damage to the floor.
- ② Do not spray or flush the refrigerator with water to avoid impact on its electrical insulation property.
- ③ Do not clean with hard brush, wire brush, detergent powder, gasoline, amyl acetate, acetone and similar organic solutions, warm water or acid or alkaline solutions. Please clean with special refrigerator detergent to avoid damage.
- ④ Do not touch the cold iron parts with wet hands, otherwise your skin may stick on the cold iron parts.
- ⑤ When cleaning, do not clean the cold glass shelves with warm water. Otherwise the glass may break due to sudden temperature change and cause personal injury or property loss.

- Always keep the door gasket clean.



Stopping use

■ Measures on power interruption

Even in summer, food may be stored in the refrigerator for a few hours after a power interruption. If a power interruption occurs, please call the power company to ask about the interruption duration.

- Do not put additional food into the refrigerator during a power interruption and try to open the door as few times as possible.
- If prior notice of a power interruption is given and the interruption duration is over 24hrs, make some ice and put it in a container in the top of the fridge storage compartment.

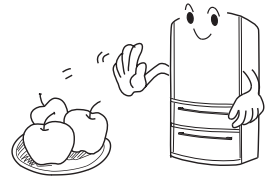

Note

As temperature in the refrigerator will rise during a power interruption or other failures, the storage period and edible quality of food will be reduced.

■ Stopping use

If the refrigerator will not be used for an extended period, please unplug the power cord, disconnect the water source, and clean it with the method described above. Keep the refrigerator door open to prevent any food remaining in the compartment from producing bad odors.



Note

To ensure the service life of the refrigerator, it is recommended that the refrigerator not be turned off unless it is necessary.

■ Before leaving for a vacation

If leaving on an extended vacation, please disconnect the power and water source. remove any food, wait for the frost to melt. Afterwards, clean and dry the interior, and keep the door open to prevent any food remaining in the compartment from producing bad odors. If the room temperature is expected drop below 0°C, please ask a qualified service person to drain the water in the water supply system. Otherwise serious property loss may be caused due to overflow of water if the water pipe or joint breaks.

■ Moving the refrigerator

- Unplug the refrigerator.
- Remove all food.
- Secure the shelves and crisper in the fridge storage compartment as well as the shelves and other movable parts in the freezer with adhesive tape.
- Close the door and secure with adhesive tape.
- Do not tilt the refrigerator more than 45 degrees (angle to vertical) to avoid damaging the refrigerating system.
- Do not move the refrigerator by its handle to avoid property damage or personal injury.

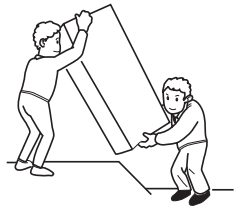

Warning

Never place the refrigerating horizontally down.



Troubleshooting

Before calling for service, please read the following troubleshooting table first. This can save both your time and money. The table contains common problems except those caused by defects in workmanship or material of the refrigerator.

Problems	Causes	Solutions
Refrigerator operation		
The compressor does not work	<ul style="list-style-type: none"> ● The refrigerator is in the defrosting cycle. ● The refrigerator is not plugged into a power outlet. ● The refrigerator is turned OFF. 	<ul style="list-style-type: none"> ● This is normal for an automatic defrosting refrigerator. ● Verify the plug is plugged in the socket firmly. ● Press the "Power" button for 3 seconds or more to restart the refrigerator or turn the knob from OFF to temperature selection position.
The refrigerator runs frequently or runs for too long period	<ul style="list-style-type: none"> ● The indoor or outdoor temperature is high. ● The refrigerator has been powered off for a period of time. ● The automatic icemaker is operating. ● The door is opened too frequently or for long period. ● The door of the fridge / freezer storage compartment is not tightly closed. ● The temperature setting for the freezer storage compartment is too low. ● The door gasket of the fridge/freezer storage compartment is dirty, worn, cracked or mismatched. ● The condenser is dirty. 	<ul style="list-style-type: none"> ● In this case, it is normal for the refrigerator to run longer. ● Normally, it takes 8 to 12 hours for the refrigerator to totally cool down. ● Ice-making process makes the refrigerator to run longer. ● Warm air enters the refrigerator and causes it to start frequently. Please do not open the door too frequently. ● Ensure the refrigerator is located on a level ground and there is no food or container jarring the door. See "door/drawer opening/closing" in section "Problem" ● Set the temperature higher until a satisfactory refrigerator temperature is obtained. It takes 24 hours for the refrigerator temperature to become stable. ● Clean or replace the door gasket. A leakage gap of door gasket can cause a longer running time of the refrigerator in order to maintain desired temperature. ● Clean the condenser.
Too high temperature		
Too high temperature in the fridge/freezer storage compartment	<ul style="list-style-type: none"> ● The door is opened too frequently or for too long each time. ● Temperature is set too high. ● The door is not closed tightly. ● The condenser is dirty. 	<ul style="list-style-type: none"> ● Warm air will enter the refrigerator whenever the door is opened. Try to open the door as less frequently as possible. ● Reset the temperature. ● See "Door/drawer opening/closing in section "Problem". ● Clean the condenser.
The temperature in the freezer is too high while the temperature in the fridge storage compartment is OK	<ul style="list-style-type: none"> ● The freezer temperature is set too high. 	<ul style="list-style-type: none"> ● Set the freezer temperature lower. It takes 24 hours for the temperature of the refrigerator to become stable.

Troubleshooting

Problems	Causes	Solutions
Too high temperature		
The temperature in the fridge storage compartment is too high while the temperature in the freezer is OK	<ul style="list-style-type: none"> ● The fridge temperature is set too high. 	<ul style="list-style-type: none"> ● Set the fridge temperature lower. It takes 24 hours for the temperature of the refrigerator to become stable.
Water/moisture/frost in the refrigerator		
Moisture accumulates on the refrigerator inner walls	<ul style="list-style-type: none"> ● Hot and moist climate. ● The door is not closed tightly. ● The door is opened too frequently or for too long each time. 	<ul style="list-style-type: none"> ● Accumulation of frost and moisture accelerate in such climate. ● See "Door/drawer opening/closing" in section "Problem". ● Do not open the door so frequently.
Water/moisture/frost on outside surface of the refrigerator		
Moisture accumulates on the refrigerator's outside surface or between two doors	<ul style="list-style-type: none"> ● Damp climate. ● The refrigerator door is not closed tightly. This causes condensation of the cold air in the refrigerator and the warm air outside it. 	<ul style="list-style-type: none"> ● This is normal in damp climate. The moisture will decrease when the humidity drops. ● See "Door/drawer opening/closing" in section "Problem".
Bad odors in the refrigerator		
The inside of the refrigerator is dirty	<ul style="list-style-type: none"> ● The inside of the refrigerator needs cleaning ● Food of strong odor is stored in the refrigerator 	<ul style="list-style-type: none"> ● Clean the internal of the refrigerator. ● Wrap the food tightly.
If you hear		
Beeps	<ul style="list-style-type: none"> ● The fridge storage compartment door is open. ● The temperature in the freezer is too high. 	<ul style="list-style-type: none"> ● Close the door or silence the alarm manually. ● The alarm is normal when it is first started due to relatively higher temperature. You can silence the alarm manually.
Abnormal sound	<ul style="list-style-type: none"> ● The refrigerator is not located on a level place. ● The refrigerator touches some object around it. 	<ul style="list-style-type: none"> ● Adjust the feet to level the refrigerator. ● Remove objects around it.
Slight sound similar to that of flowing water	<ul style="list-style-type: none"> ● This is the sound of the refrigerating system 	<ul style="list-style-type: none"> ● Normal.
Heating of cabinet	<ul style="list-style-type: none"> ● The anti-condensation system is working. 	<ul style="list-style-type: none"> ● This prevents condensation and is normal.

Technical data

Haier Refrigerator-freezer

MODEL	CFE633CW/U/CFE633CB/U/CFE633CS/U
FREEZING CLASS	***
CLIMATE CLASS	SN-T
PROTECTION CLASS	I
TOTAL VOLUME	310L
CHILL(FRESH CONTROL VOLUME)	17L
FREEZER VOLUME	80L
INPUT POWER	120W
RATED CURRENT	1.4A
RATED VOLTAGE	220-240V~50Hz
DEFROSTING INPUT POWER	153W
MAXIMUM POWER OF LAMP	1W
BLOWING GAS	C-P
REFRIGERANT	R600a 55g
FREEZING CAPACITY	11kg/24h
WEIGHT	76kg
DIMENSION(D × W × H) (mm)	670 × 595 × 1880
SERIAL NUMBER	

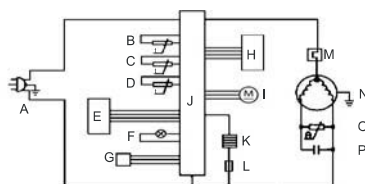

- A. POWER PLUG B. SENSOR1 C. SENSOR2 D. SENSOR3
 E. DISPLAY PANEL F. LAMP G. HALL IC SWITCH
 H. DAMPER I. FAN MOTOR J. CONTROL BOARD
 K. HEATER L. FUSE M. OVER LOAD PROTECTOR
 N. COMPRESSOR O. PTC P. CAPACITOR



MADE IN CHINA

Haier Refrigerator-freezer

MODEL	AFL631CW/U, AFL631CS/U, AFL631CB/U
FREEZING CLASS	***
CLIMATE CLASS	SN-T
PROTECTION CLASS	I
TOTAL VOLUME	308L
CHILL(FRESH CONTROL VOLUME)	17L
FREEZER VOLUME	78L
INPUT POWER	120W
RATED CURRENT	1.4A
RATED VOLTAGE	220-240V~50Hz
DEFROSTING INPUT POWER	153W
MAXIMUM POWER OF LAMP	1W
BLOWING GAS	C-P
REFRIGERANT	R600a 58g
FREEZING CAPACITY	11kg/24h
WEIGHT	81kg
DIMENSION(D × W × H) (mm)	670 × 595 × 1880
SERIAL NUMBER	

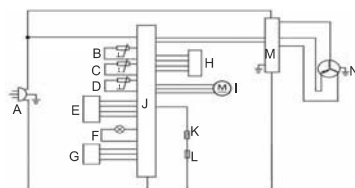

- A. POWER PLUG B. SENSOR1 C. SENSOR2
 D. SENSOR3 E. DISPLAY PANEL F. LAMP
 G. HALL IC SWITCH H. DAMPER I. FAN MOTOR
 J. CONTROL BOARD K. HEATER L. FUSE
 M. INVERTER PANEL N. COMPRESSOR



MADE IN CHINA



Meaning of crossed out wheeled dustbin:

Do not dispose of electrical appliances as unsorted municipal waste, use separate collection facilities. Contact your local government for information regarding the collection systems available. If electrical appliances are disposed of in landfills or dumps, hazardous substances can leak into the groundwater and get into the food chain, damaging your health and well-being. When replacing old appliances with new ones, the retailer is legally obligated to take back your old appliance for disposals at least free of charge.

